



**12.4 GHz TNC FAILSAFE S.P.D.T. SWITCH**

OPTIONS:

**R F CHARACTERISTICS**

FREQUENCY RANGE : 0 - 12.4 GHz  
 IMPEDANCE : 50 Ohms

FREQUENCY (GHz)	0 - 1	1 - 2	2 - 3	3 - 8	8 - 12.4
V.S.W.R <=	1.15	1.20	1.25	1.35	1.50
INSERT. LOSS <=	0.15 dB	0.20 dB	0.25 dB	0.35 dB	0.50 dB
ISOLATION >=	85 dB	80 dB	75 dB	70 dB	60 dB
AVER. POWER (*)	700 W	500 W	400 W	250 W	200 W

**ELECTRICAL CHARACTERISTICS**

ACTUATOR : FAILSAFE  
 NOMINAL CURRENT AT 25° C (±10%) : 140 mA  
 ACTUATOR VOLTAGE (Vcc) : 28V (24 to 30V)  
 TERMINALS : solder pins (250 Deg.C max./30 sec)

**MECHANICAL CHARACTERISTICS**

CONNECTORS : TNC fem. per MIL C 39012  
 LIFE : 1.000.000 cycles  
 SWITCHING TIME (nominal voltage;25° C) : < 15 ms  
 CONSTRUCTION : splashproof  
 WEIGHT : < 185 g

**ENVIRONMENTAL CHARACTERISTICS**

OPERATING TEMPERATURE RANGE (°C) : -40 , +85  
 STORAGE TEMPERATURE RANGE (°C) : -55 , +85

(\* : average power at 25° C)

4112-9212 This information is given as an indication. In the continual goal to improve our products, we reserve the right to make any modifications judged necessary

**DRAWING**

General tolerance: \* 0,5 mm

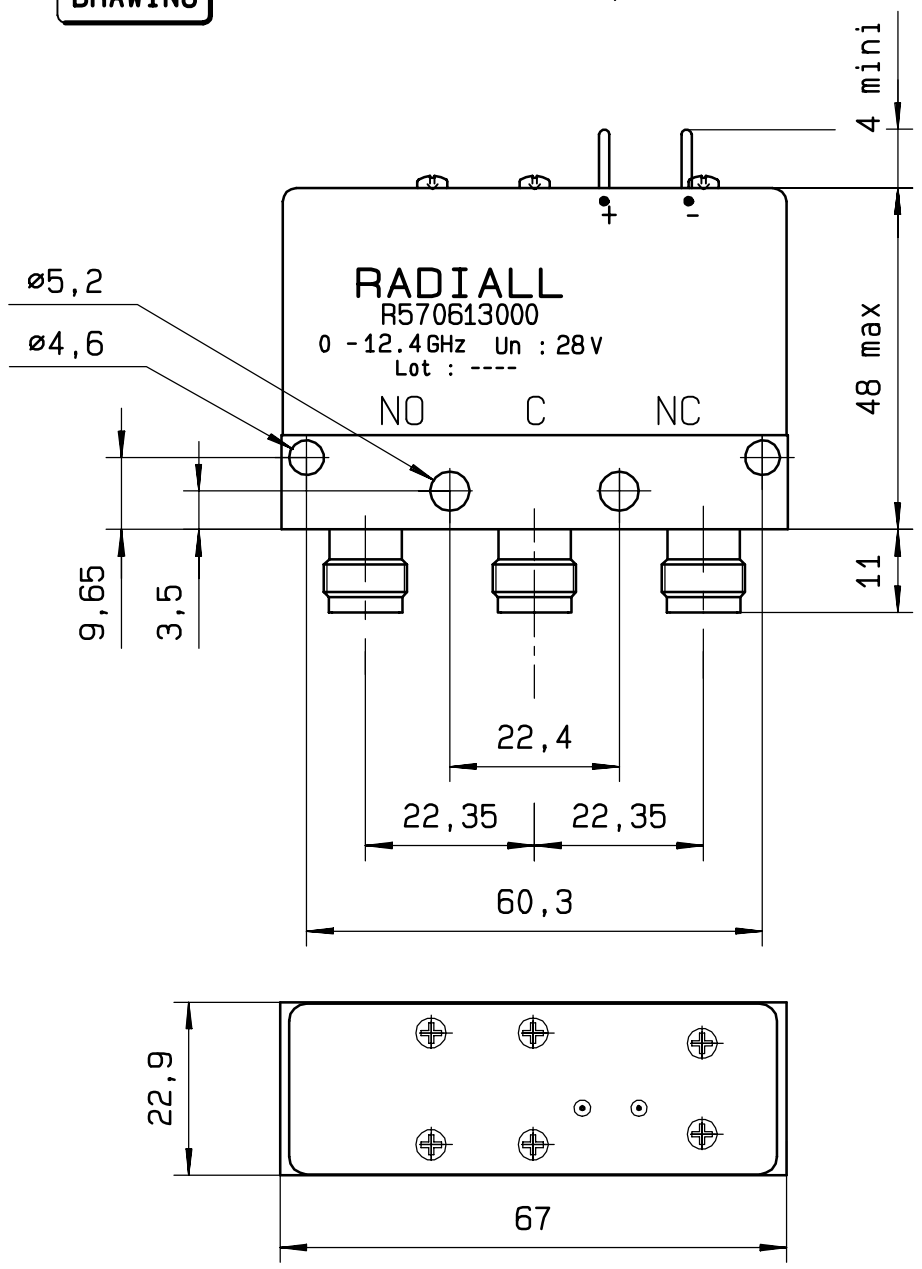

**SCHEMATIC DIAGRAM**

Voltage	RF continuity
De-energized	C ↔ NC
energized	C ↔ NO

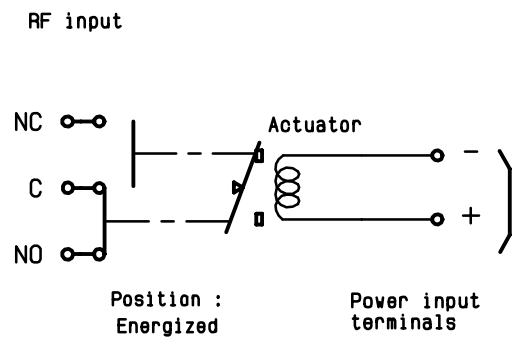

4113-9212 This information is given as an indication. In the continual goal to improve our products, we reserve the right to make any modifications judged necessary