

QN ATTENUATOR

9 DB 3 GHZ 1W

R412.309.124

Series : ATTENUATOR

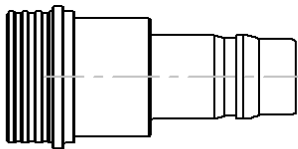
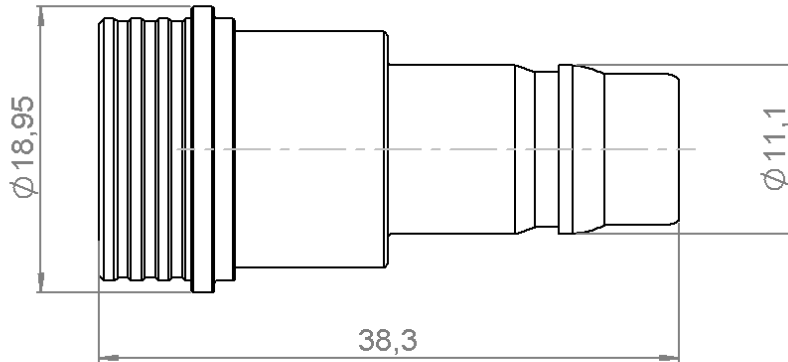

Ech : 1

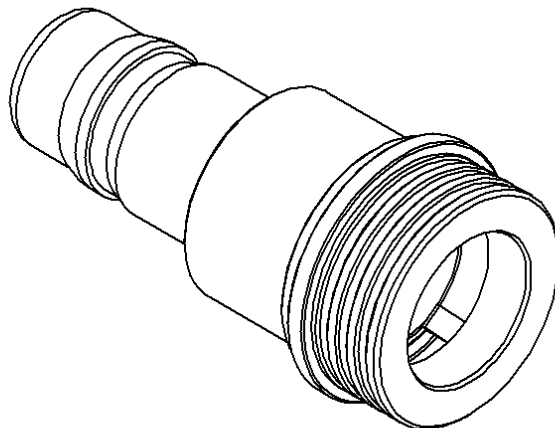

All dimensions are in mm.

COMPONENTS	MATERIALS	PLATING(μm)
BODY	BRASS	BBR 0.5 OVER SILVER 3
MALE CENTER CONTACT	BRASS	GOLD 1.3 OVER COPPER 2.5
FEMALE CENTER CONTACT	BERYLLIUM COPPER	GOLD 1.3 OVER COPPER 2.5
OUTER CONTACT	BERYLLIUM COPPER	NPGR
INSULATOR	PTFE	
GASKET	EPDM	
SUBSTRATE	ALUMINA	
RESISTOR	THICK FILM	
OTHERS PARTS		

Issue : 1309 B

In the effort to improve our products, we reserve the right to make changes judged to be necessary.

QN ATTENUATOR

9 DB 3 GHZ 1W

R412.309.124

Series : ATTENUATOR

ELECTRICAL CHARACTERISTICS

Frequency (GHz)	2	2 - 3
V.S.W.R (≤)	1.20	1.30
Deviation(±dB)	0.50	0.50

Operating Frequency Range	DC - 3	GHz
Impedance	50	Ω
Nominal Attenuation	9	dB
Peak power at 25°C (1μs, 1% _o)	100	W
Average power at 25°C	1	W (Free Air Cooled)

MECHANICAL CHARACTERISTICS

Connectors	QN	Male Female
Weight	28,3770	g

ENVIRONMENTAL CHARACTERISTICS

Operating temperature range	-40 / +85 °C
Storage temperature range	-40 / +85 °C

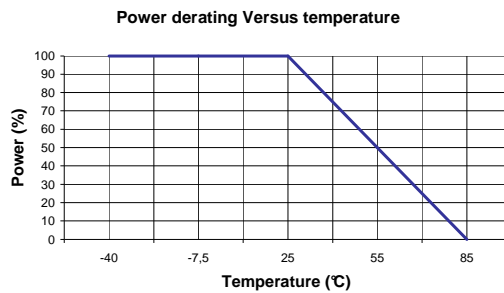

SPECIFICATION

OTHER CHARACTERISTICS

Mating Life : 100 Cycles

Issue : 1309 B

In the effort to improve our products, we reserve the right to make changes judged to be necessary.