

**R/A MALE MODULE 4 SOLDER TYPE INSERTS**  
**2.5MM FOR PCB**

**R694.251.116**

Series : MCC2

2 Coax Position AB , 1A , 1C

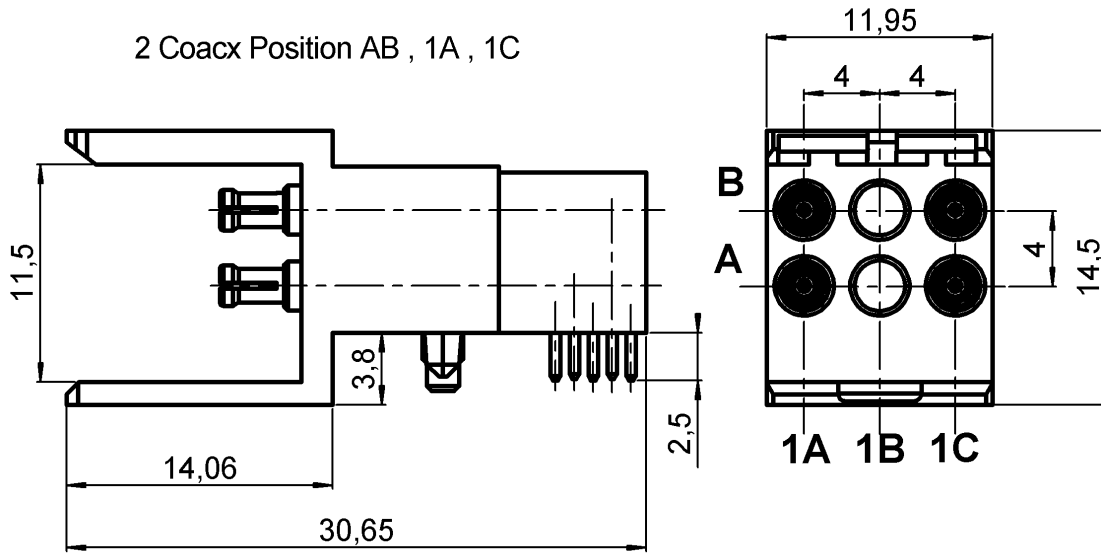

Connectors' packaging

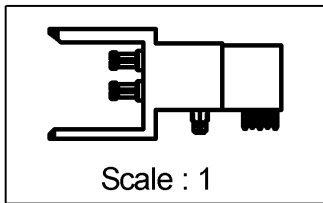
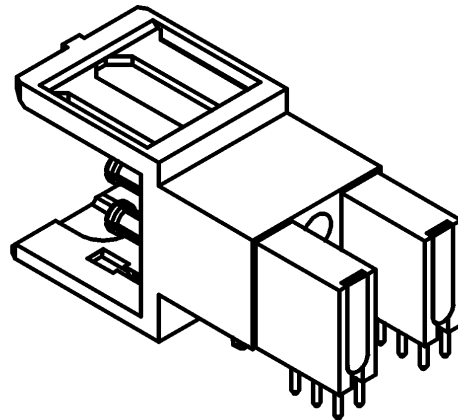
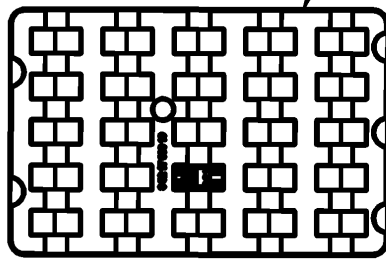

All dimensions are in mm.



COMPONENTS	MATERIALS	PLATING (µm)
BODY	BRASS	NICKEL 2
CENTER CONTACT	BERYLLIUM COPPER	NPGR
OUTER CONTACT	BRONZE	NPGR
INSULATOR	PEEK , ULTEM	
GASKET	-	
OTHERS PARTS	LIQUID CRISTAL POLYMER	
.	.	.
.	.	.

Issue : 0627 B

In the effort to improve our products, we reserve the right to make changes judged to be necessary.



**R/A MALE MODULE 4 SOLDER TYPE INSERTS**  
**2.5MM FOR PCB**

**R694.251.116**

Series : MCC2

**PACKAGING**

**SPECIFICATION**

Standard	Unit	Other
25	'W' option	Contact us

**ELECTRICAL CHARACTERISTICS**

Impedance		<b>50</b> Ω
Frequency		<b>0-6</b> GHz
VSWR	<b>1.20*</b> +	<b>0,0000</b> x F(GHz) Maxi
Insertion loss		<b>0.2</b> √F(GHz) dB Maxi
RF leakage	- (	- F(GHz)) dB Maxi
Voltage rating		<b>500</b> Veff Maxi
Dielectric withstanding voltage		<b>750</b> Veff mini
Insulation resistance		<b>5000</b> MΩ mini

**ENVIRONMENTAL**

Operating temperature	<b>-25/+125</b> ° C
Hermetic seal	<b>NA</b> Atm.cm3/s
Panel leakage	<b>NA</b>

**OTHER CHARACTERISTICS**

Assembly instruction

Others :  
 VSWR optimized between DC to 3GHz

**MECHANICAL CHARACTERISTICS**

Center contact retention		
Axial force – Mating end	<b>6</b>	N mini
Axial force – Opposite end	<b>6</b>	N mini
Torque	<b>NA</b>	N.cm mini
Recommended torque		
Mating	<b>NA</b>	N.cm
Panel nut	<b>NA</b>	N.cm
Mating life	<b>500</b>	Cycles mini
Weight	<b>81,5600</b>	g

Issue : 0627 B

In the effort to improve our products, we reserve the right to make changes judged to be necessary.



PRELIMINARY

**R/A MALE MODULE 4 SOLDER TYPE INSERTS**  
**2.5MM FOR PCB**

**R694.251.116**

Series : MCC2

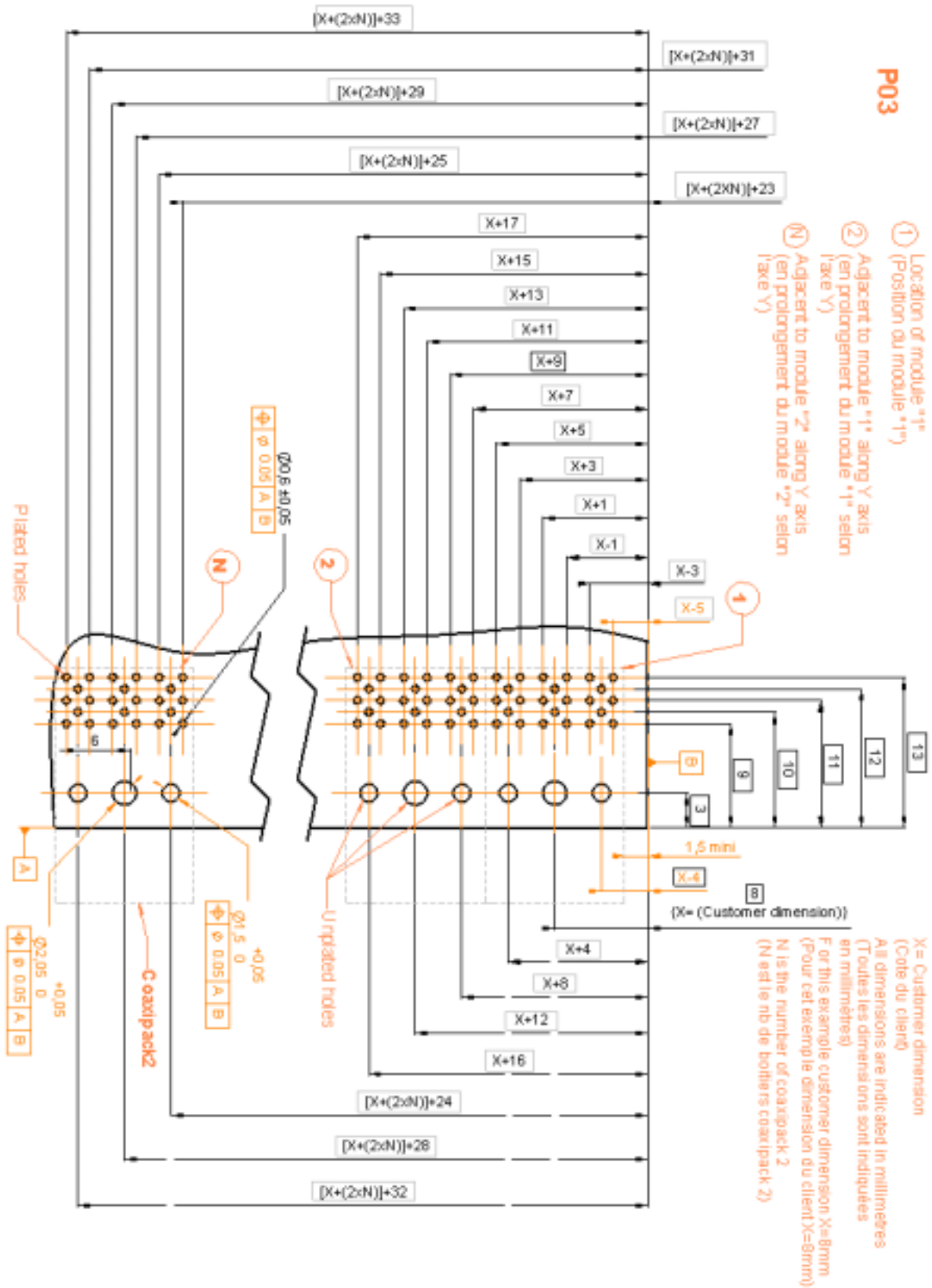

Issue : 0627 B

In the effort to improve our products, we reserve the right to make changes judged to be necessary.



PROHIBÉ

**R/A MALE MODULE 4 SOLDER TYPE INSERTS**  
**2.5MM FOR PCB**

**R694.251.116**

Series : MCC2

- Place the coax connector on the PCB

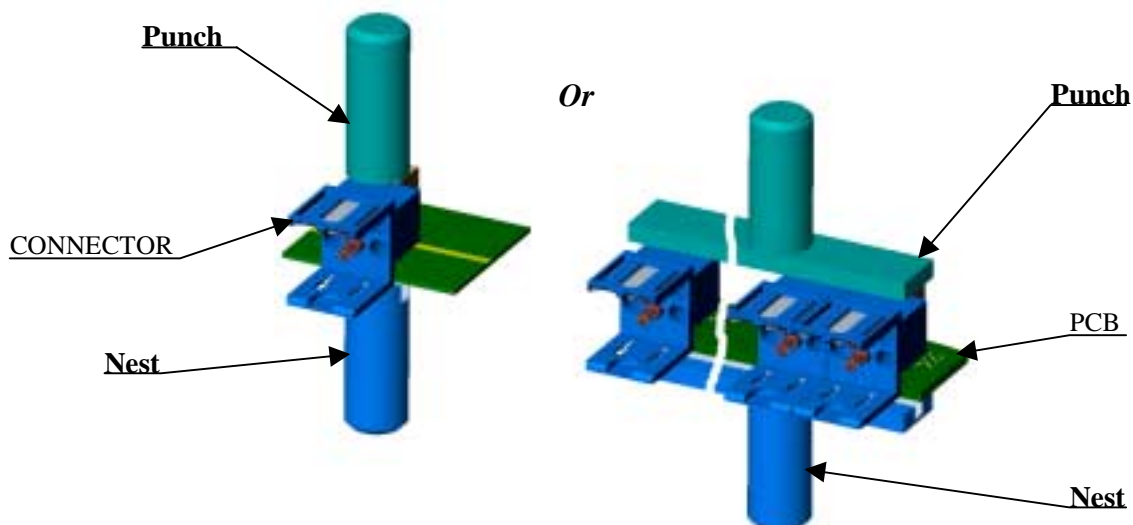

- Place correctly the PCB between the punch and the nest of the press.
- In case of multiple housing configuration , use a punch and a nest large enough to cover all the housings.
- Press on the plastic housing(s) with the punch until the complete insertion of the fixing stud into the PCB.

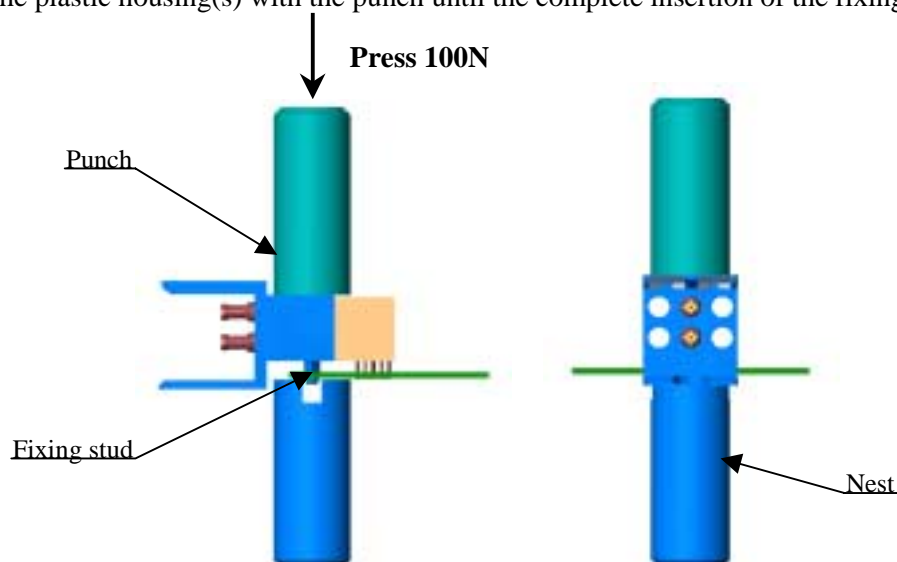

- Solder the legs on board

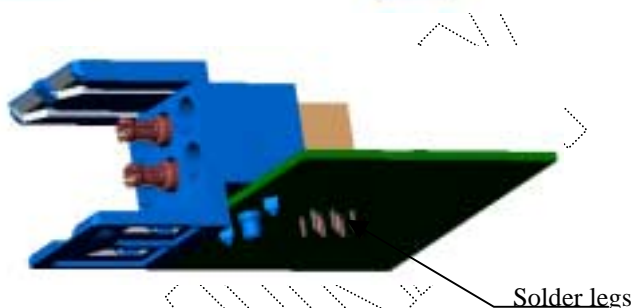

Radiall do not recommend to use more than 3 modules on the same motherboard and can't be held liable of any connection defect when more than 3 modules are implemented on the board

**Issue : 0627 B**

In the effort to improve our products, we reserve the right to make changes judged to be necessary.

