

R/A MALE MODULE 2 SOLDER TYPE INSERTS

R694.251.111

2.5MM FOR PCB

Series : MCC2

1 Coax Position AB , 1A

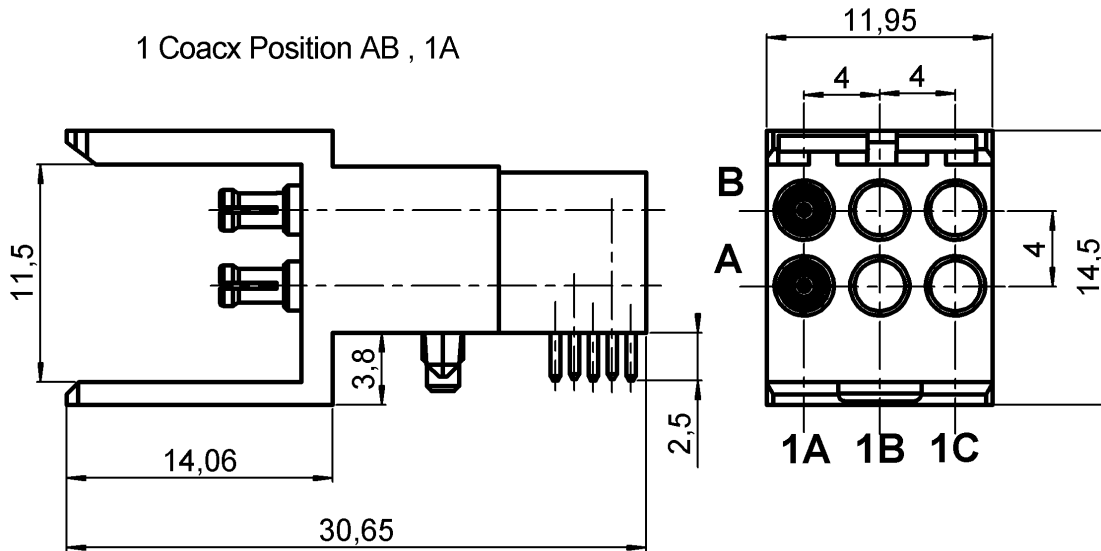

Connectors' packaging

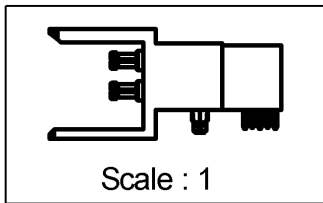
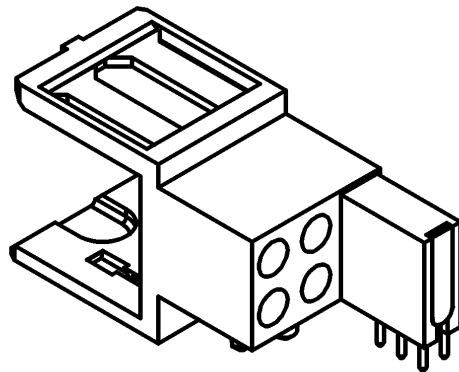
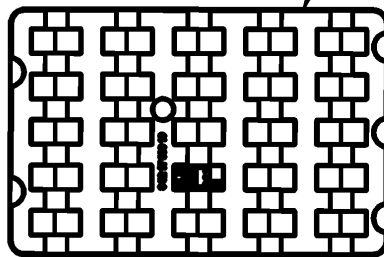

All dimensions are in mm.



COMPONENTS	MATERIALS	PLATING (µm)
BODY	BRASS	NICKEL 2
CENTER CONTACT	BERYLLIUM COPPER	NPGR
OUTER CONTACT	BRONZE	NPGR
INSULATOR	PEEK , ULTEM	
GASKET	-	
OTHERS PARTS	LIQUID CRISTAL POLYMER	
.	.	.
.	.	.

Issue : 0627 B

In the effort to improve our products, we reserve the right to make changes judged to be necessary.



R/A MALE MODULE 2 SOLDER TYPE INSERTS

R694.251.111

2.5MM FOR PCB

Series : MCC2

PACKAGING

SPECIFICATION

Standard	Unit	Other
25	'W' option	Contact us

ELECTRICAL CHARACTERISTICS

ENVIRONMENTAL

Impedance		50 Ω
Frequency		0-6 GHz
VSWR	1.20* +	0,0000 x F(GHz) Maxi
Insertion loss		0.2 √F(GHz) dB Maxi
RF leakage	- (- F(GHz)) dB Maxi
Voltage rating		500 Veff Maxi
Dielectric withstanding voltage		750 Veff mini
Insulation resistance		5000 MΩ mini

Operating temperature	-25/+125 ° C
Hermetic seal	NA Atm.cm3/s
Panel leakage	NA

OTHER CHARACTERISTICS

Assembly instruction

Others :
ROS optimized between DC to 3GHz

MECHANICAL CHARACTERISTICS

Center contact retention		
Axial force – Mating end	6	N mini
Axial force – Opposite end	6	N mini
Torque	NA	N.cm mini
Recommended torque		
Mating	NA	N.cm
Panel nut	NA	N.cm
Mating life	500	Cycles mini
Weight	79,6100	g

Issue : 0627 B

In the effort to improve our products, we reserve the right to make changes judged to be necessary.



PRELIMINARY

R/A MALE MODULE 2 SOLDER TYPE INSERTS
2.5MM FOR PCB

R694.251.111

Series : MCC2

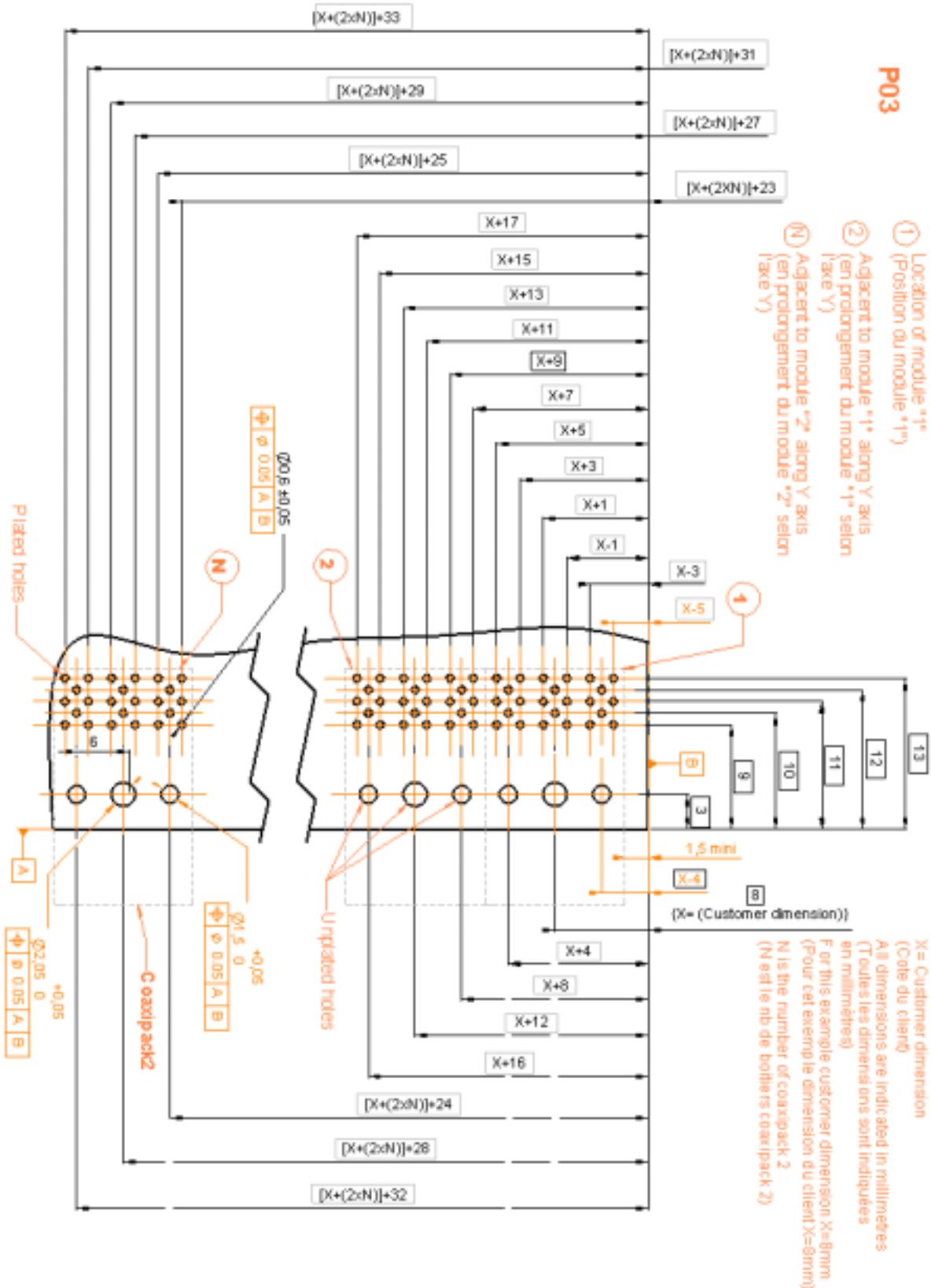

Issue : 0627 B

In the effort to improve our products, we reserve the right to make changes judged to be necessary.



PROHIBÉ

R/A MALE MODULE 2 SOLDER TYPE INSERTS
2.5MM FOR PCB

R694.251.111

Series : MCC2

- Place the coax connector on the PCB

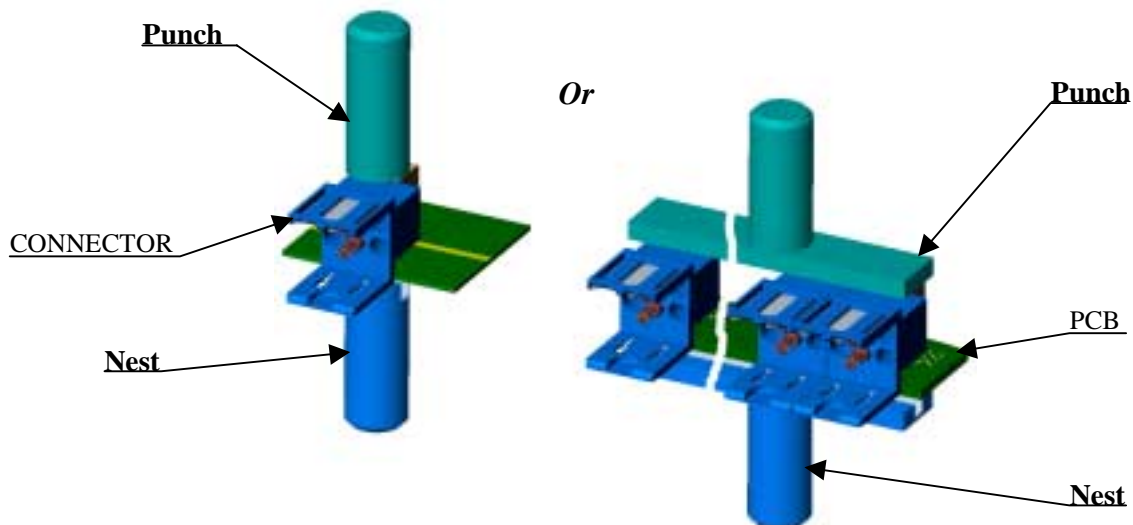

- Place correctly the PCB between the punch and the nest of the press.
- In case of multiple housing configuration , use a punch and a nest large enough to cover all the housings.
- Press on the plastic housing(s) with the punch until the complete insertion of the fixing stud into the PCB.

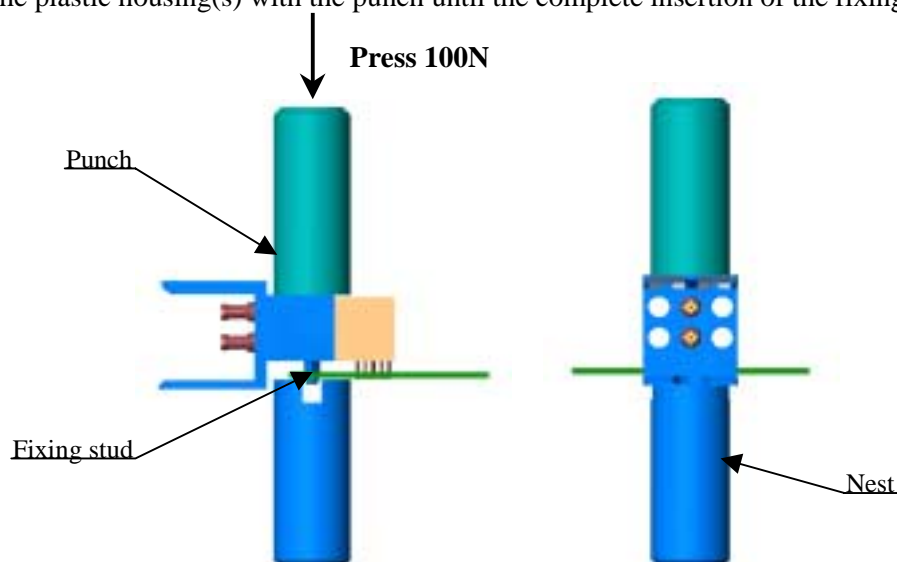

- Solder the legs on board

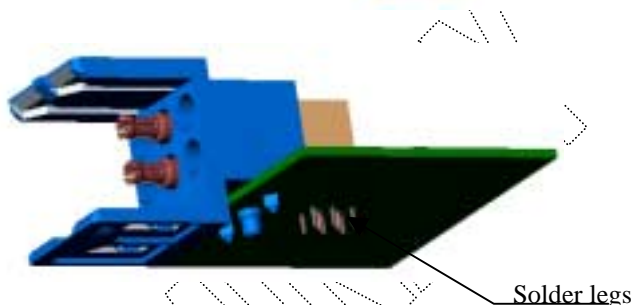

Radiall do not recommend to use more than 3 modules on the same motherboard and can't be held liable of any connection defect when more than 3 modules are implemented on the board

Issue : 0627 B

In the effort to improve our products, we reserve the right to make changes judged to be necessary.

