

CRIMPING DIES
HEX 7.98-3.84 (M22520/5-37)

R282.235.037

Series : **OUT**

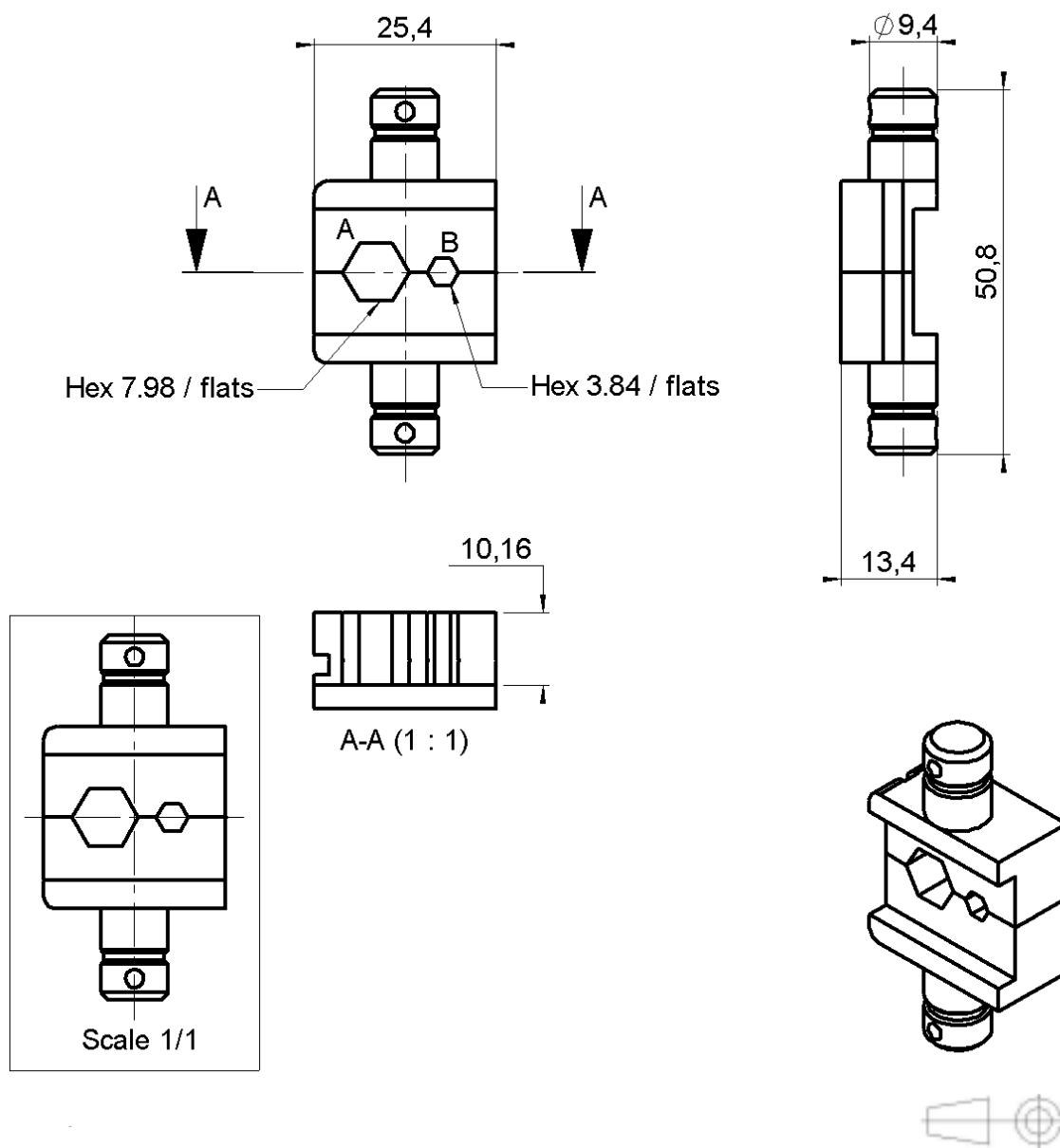

TO BE USED WITH CRIMPING TOOL :
 R282.293.000 (M 22520 / 5-01)

Issue : 0043 A

In the effort to improve our products, we reserve the right to make changes judged to be necessary.

