

PAGE 1/5	ISSUE 22-10-20A	SERIES SMPM-L	PART NUMBER R201L80000
----------	-----------------	---------------	------------------------

Position Unlocked

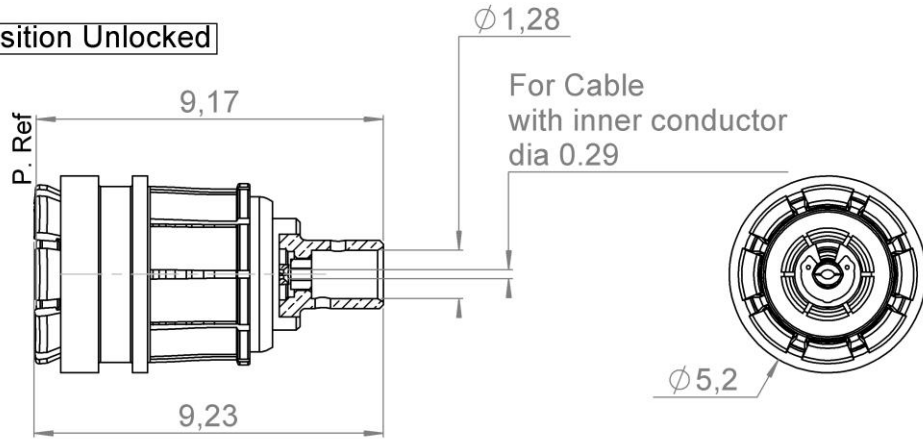

Position Locked

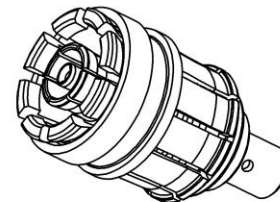
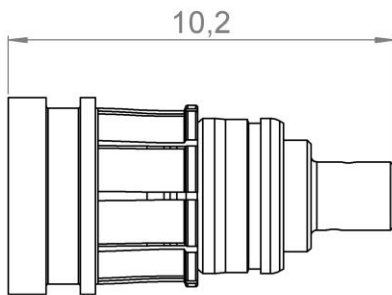

Scale 1/1



All dimensions are in mm. Tolerances according ISO 2768 m-H

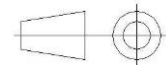

COMPONENTS	MATERIALS	PLATING (μm)
Body	BERYLLIUM COPPER	N2PGR
Center contact	BERYLLIUM COPPER	GOLD 1.3 OVER NICKEL2
Outer contact	BERYLLIUM COPPER	N2PGR
Insulator	PTFE+PEEK	
Gasket		
Others parts	BRONZE,BERYLLIUM COPPER	NICKEL, GOLD
-	-	-
-	-	-

PAGE 2/5	ISSUE 22-10-20A	SERIES SMPM-L	PART NUMBER R201L80000
----------	-----------------	---------------	------------------------

PACKAGING

Standard	Unit	Other
100	Contact us	Contact us

ELECTRICAL CHARACTERISTICS

Impedance		50	Ω
Frequency		0-65	GHz
VSWR	* +	0,00	x F(GHz) Maxi
Insertion loss		0.12	√F(GHz) dB Maxi
RF leakage	- (**	- F(GHz)) dB Maxi
Voltage rating		125	Veff Maxi
Dielectric withstanding voltage		250	Veff mini
Insulation resistance		5000	MΩ mini

MECHANICAL CHARACTERISTICS

Center contact retention			
Axial force – Mating End		6.7	N mini
Axial force – Opposite end		6.7	N mini
Torque		NA	N.cm mini
Recommended torque			
Mating		NA	N.cm
Panel nut		NA	N.cm
Clamp nut		NA	N.cm
A/F clamp nut		0,00	mm
Mating life		500	Cycles mini
Nominal Weight (Add +15% for max weight)		0,61	g

ENVIRONMENTAL

Operating temperature	-65/+165	°C
Hermetic seal	NA	Atm.cm3/s
Panel leakage	NA	

SPECIFICATION

CABLE ASSEMBLY

Stripping	a	b	c	d	e	f
mm	7,00	3,00	1,80	-	-	-

Assembly instruction:

Recommended cable(s)

047SC-2901
UT47 M17/151-00001

Characteristics indicated on this data sheet are those that can be achieved with the highest performance cable. Intrinsic limitations of the cable may diminish the performance of the assembly

Cable retention

- pull off (UT47 M17/151-00001)	45 N mini
- pull off (047SC-2901)	25 N mini

- torque **NA** N.cm

TOOLING

Part Number	Description	Hexagon
R282740060	BRAZING TOOL SMPM-LOCK	
R282868370	LOCK AND UNLOCK TOOL FOR SMPM-L	OPTION 1
R282918230	LOCK AND UNLOCK TOOL FOR SMPM-L	OPTION 2

OTHER CHARACTERISTICS

(RF performances depend on cable used)

* 1.15 : DC->26.5 Ghz * 1.35 : 26 -> 40 Ghz
** -80dB up to 3GHz

PAGE 3/5	ISSUE 22-10-20A	SERIES SMPM-L	PART NUMBER R201L80000
----------	-----------------	---------------	------------------------

For flexible cable

For Semi Rigid cable

Before stripping, strip jacket
And deep tin the naked braid.

We recommend a cable thermal
preconditioning

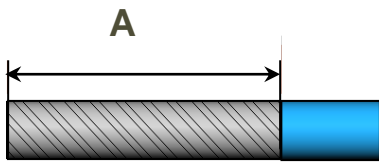

1A

- Strip the cable inner conductor.
- Make a Chamfer
- Clean the cable

1B

- Strip the cable inner conductor.
- Make a Chamfer
- Clean the cable

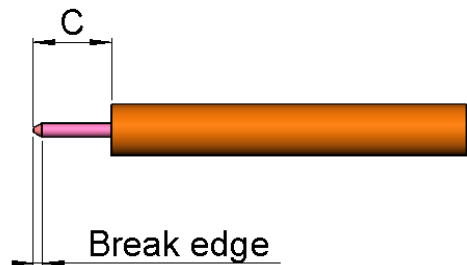
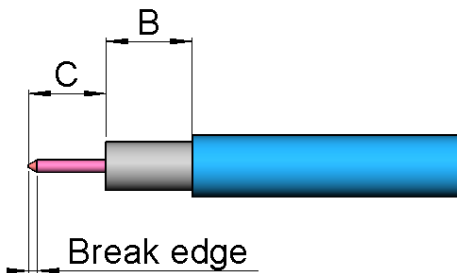

2A

- Slide the insulator onto the cable inner conductor.

2B

- Slide the insulator onto the cable inner conductor.

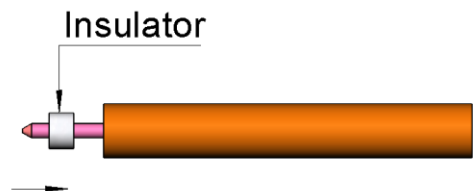
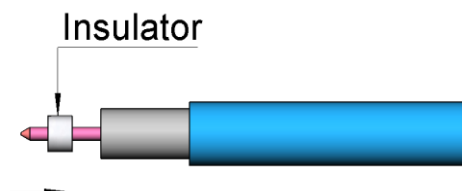

PAGE 4/5	ISSUE 22-10-20A	SERIES SMPM-L	PART NUMBER R201L80000
----------	-----------------	---------------	------------------------

3

- Introduce the cable into the connector body and place the assembly into the positioner
- Push the cable into the connector body until it stops and fixe the cable
- Solder the cable onto the body.
- After cooling remove cable assembly from the jig.

Cable in position
See Nota 1

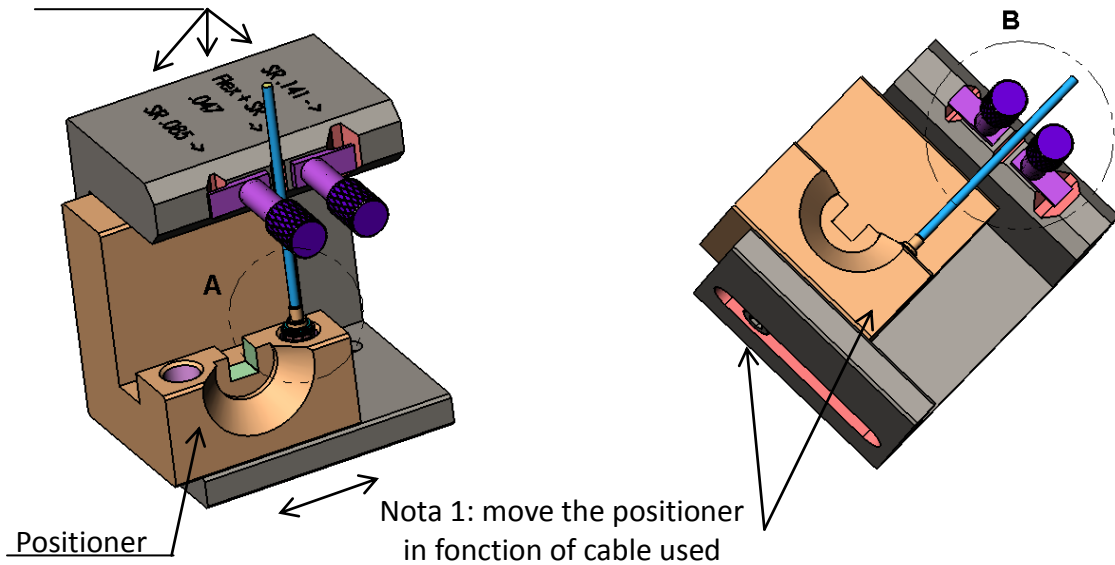

DETAIL A
Echelle 2:1

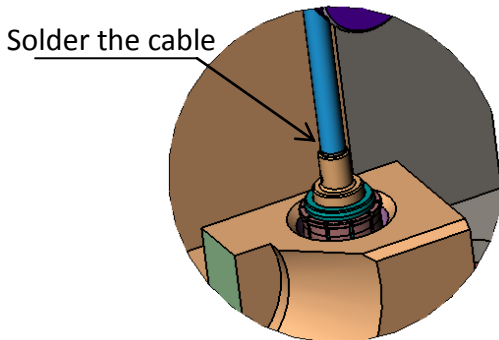

DÉTAIL B
ECHELLE 2 : 1

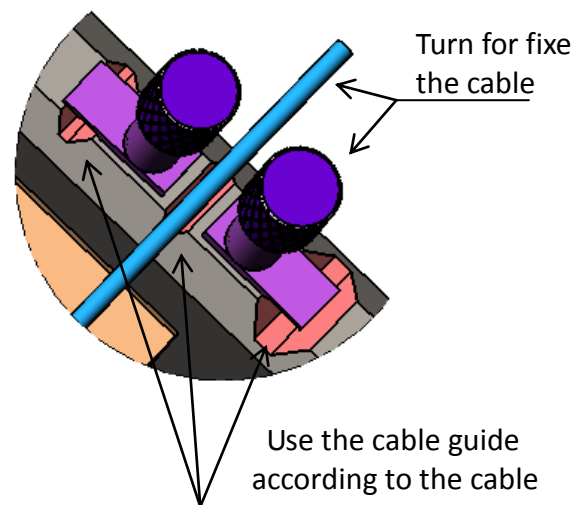

PAGE 5/5	ISSUE 22-10-20A	SERIES SMPM-L	PART NUMBER R201L80000
----------	-----------------	---------------	------------------------

MATING, LOCKING / UNLOCKING INSTRUCTIONS

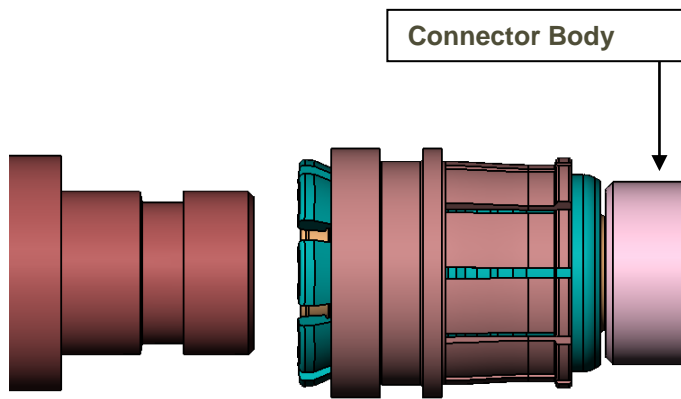

← Mate connectors until mechanical stop

Do not make the coupling by the locking nut

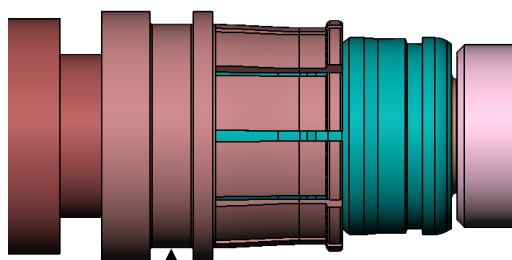

← Slide the locking nut until stop by using the specific tool (See tool option 1 or 2)

Groove for locking and unlocking tool

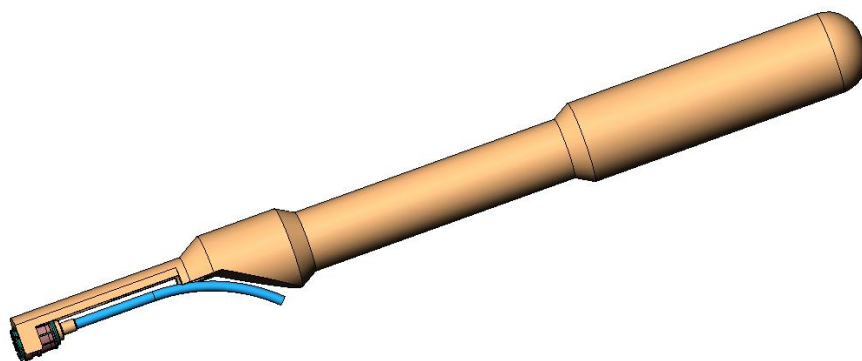

TOOL OPTION: 1

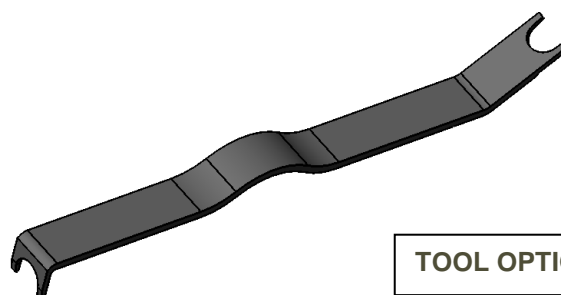

TOOL OPTION: 2