

STRAIGHT BULKEAD JACK SOLDER TYPE

R113.303.020

.085

Series : MCX

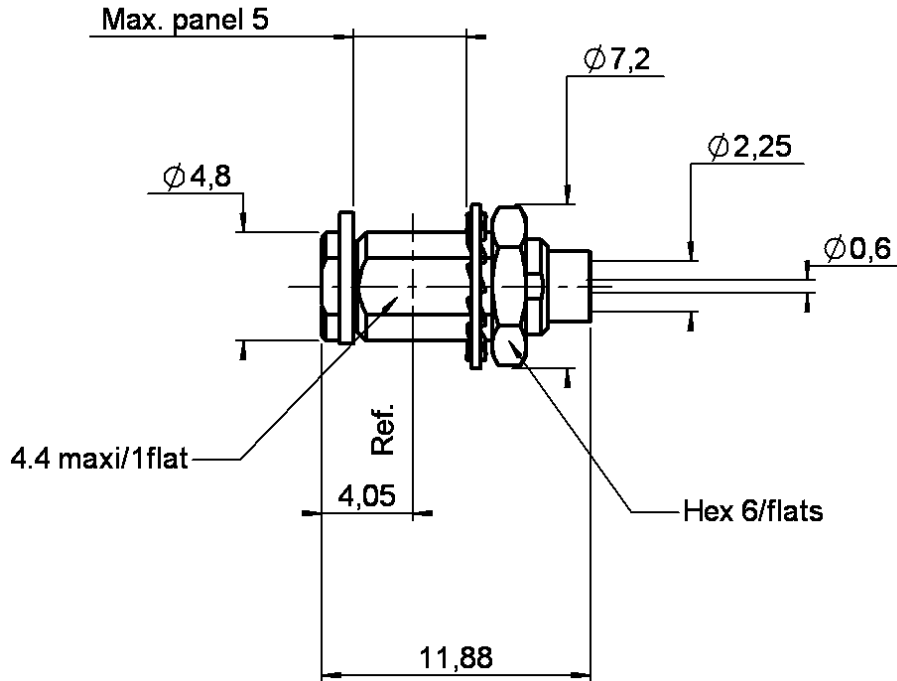

PANEL CUT OUT

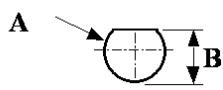

mm		
	Maxi	mini
A	5	5.1
B	2.08	2.01

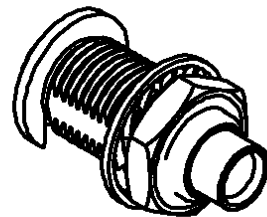
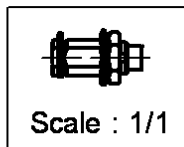

CECC 2221-MCX



All dimensions are in mm.

COMPONENTS	MATERIALS	PLATINGS (µm)
BODY	BRASS	BBR 2
CENTER CONTACT	BERYLLIUM COPPER	.GOLD 1.3 OVER NICKEL 2
OUTER CONTACT	-	-
INSULATOR	PTFE	-
GASKET	-	-
OTHERS PARTS	BRASS	BBR 2
-	-	-
-	-	-

Issue : 0107 F

In the effort to improve our products, we reserve the right to make changes judged to be necessary.



STRAIGHT BULKEAD JACK SOLDER TYPE

R113.303.020

.085

Series : **MCX**

PACKAGING

Standard	Unit	Other
100	-	Contact us

SPECIFICATION

ELECTRICAL CHARACTERISTICS

Impedance	50	Ω
Frequency	0-3	GHz
VSWR	1.25 + 0,0000	x F(GHz) Maxi
Insertion loss	NA	\sqrt{F} (GHz) dB Maxi
RF leakage	- (NA)	- F(GHz)) dB Maxi
Voltage rating	250	Veff Maxi
Dielectric withstanding voltage	750	Veff mini
Insulation resistance	1000	M Ω mini

CABLE ASSEMBLY

Stripping	a	b	c	d	e	f
mm	2,70	0,00	0,00	0,00	2,10	0,00

Assembly instruction :

Recommended cable(s)
KS 1
RG 405

Cable retention

- pull off **155** N mini
- torque **NA** N.cm

MECHANICAL CHARACTERISTICS

Center contact retention		
Axial force – Mating end	NA	N mini
Axial force – Opposite end	NA	N mini
Torque	NA	N.cm mini

TOOLING

Part Number	Description	Hexagon
.	.	.
R282.740.000	SOLDERING MOUNTING	

Recommended torque		
Mating	NA	N.cm
Panel nut	60	N.cm
Clamp nut	NA	N.cm
A/F clamp nut	0,0000	mm

Mating life	0	Cycles mini
Weight	1,1810	g

OTHERS CHARACTERISTICS

-

ENVIRONMENTAL

Operating temperature	-55/+115	$^{\circ}$ C
Hermetic seal	NA	Atm.cm3/s
Panel leakage	NA	

Issue : **0107 F**

In the effort to improve our products, we reserve the right to make changes judged to be necessary.



STRAIGHT BULKEAD JACK SOLDER TYPE

R113.303.020

.085

Series : MCX

COMPONENT

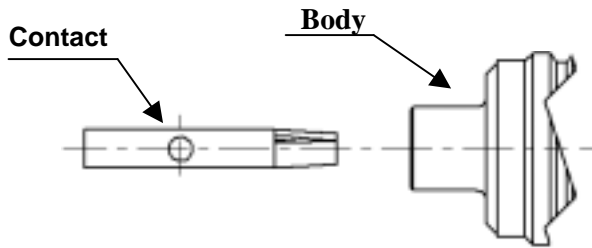

STRIPPING DIMENSIONS

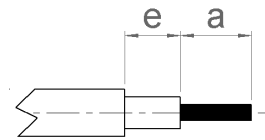

We recommend a thermal preconditionning cable.

1

Cable stripping.
To slide the nut on the cable.

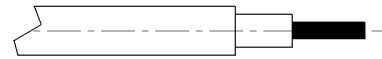

2

Tin centre contact solder pot.
Solder centre contact on cable inner conductor.
Clean solder.



3

Introduce cable into the connector body until contact with the body shoulder.
Place the sub assembly into the assembly jig R282 740 020 (or equivalent).
We advice to connect a female receptable to the connector prior to solder the body in order to respect right centre contact position.
Tighten the sub assembly.
Solder body on the cable.
Let the assembly cool down before removing it from the jig.
Clean solder.

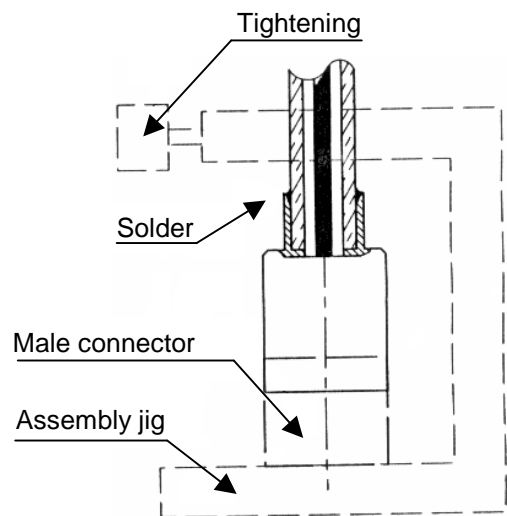

Issue : 0107 F

In the effort to improve our products, we reserve the right to make changes judged to be necessary.

